

6036SE

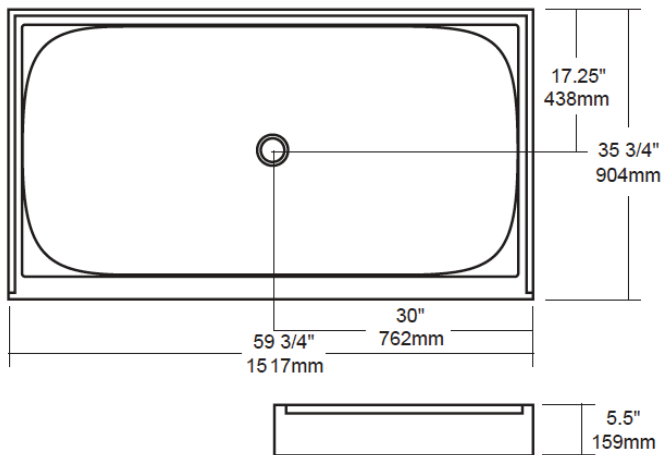

- DOUBLE-REINFORCED BASE
- SLIP-RESISTANT
- CSA APPROVED
- CAN/ULC-S102 TESTED

TEL: (905) 470-9066
FAX: (905) 470-9663
TOLL-FREE: +1 (800) 561-0187

TUBCO WHIRLPOOLS LTD.

2715 14th Avenue
Markham ON, L3R 0H9

tubco.com
marketing@tubco.com